

519 SERIES



Rack And Panel Connectors

Features:

- 0.150" (3.81mm) contact spacing x 0.150" (3.81mm) row spacing suitable for automatic wire wrapping
- Plug and receptacle in 14 or 36 contact sizes
- Edacon hermaphroditic contact mating design
- Contact termination options include crimp, P.C. tail, wire hole and wire wrap
- Mating and unmating simplified with use of actuating screws
- Optional covers with side or top entry cable clamp in plastic or metal material available for all connector sizes
- Versatile metal cover design permits assembly or disassembly after cabling is complete plus cable entry style flexibility
- Actuating screws, locknuts, polarizing hardware, covers and contacts suitable for either plug or receptacle
- Polarizing hardware adjustable for 288 mating combinations
- Tools available for contact installation, removal, crimping and polarizing changes
- RoHS Compliant

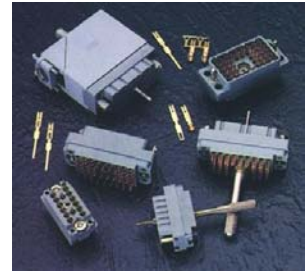

Specifications:

Insulator Material	Polycarbonate UL 94V-0
Color	Grey
Contact Material	Copper Alloy
Contact Plating	Gold Plating over Nickel over entire contact
Current Rating	8.5 amps
Contact Resistance	10 milliohms maximum
Dielectric Withstanding Voltage	2000 V AC rms at sea level
Insulation Resistance	5000 megaohms minimum
Operating Temperature	-40°C to +105°C
Insertion & Withdrawal Force	2 to 16 oz (0.56 to 4.45N) per contact position

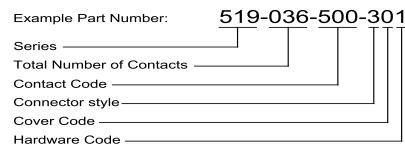

Series:

519

Total Number of Contacts:

014, 036

Contact Code:	Description:	Tail Size:	Tail Length "G":
000	No Contacts Assembled	-----	-----
500	Wire Hole	.110 x .024 (2.79 x 0.61)	.245 (6.22)
501	Taper Tail	.110 x .024 (2.79 x 0.61)	.245 (6.22)
520	P.C. Tail	.025 x .024 (0.64 x 0.61)	.215 (5.46)
540	Wire Wrap	.050 x .024 (1.27 x 0.61)	.600 (15.24)
541	Wire Wrap	.026 x .024 (0.66 x 0.61)	.620 (15.70)
542	Wire Wrap	.050 x .024 (1.27 x 0.61)	.790 (20.07)

Connector Style:	Style:
3	Plug
4	Receptacle

Cover Code ^{1,2,3,4}:

Cover Code	Description:
0	No Cover Assembled
1	Plastic Cover, Top Entry Standard Clamp
2	Plastic Cover, Side Entry Standard Clamp
3	Plastic Cover, Top Entry Large Clamp
4	Plastic Cover, Side Entry Large Clamp
5	Metal Cover, Side Entry
6	Metal Cover, Top Entry

Hardware Code ^{5,6}:

Hardware Code	Description:
0	No Hardware
1	Actuating Screw & Polarizing Hardware
2	Locknut & Polarizing Hardware
5	Actuating Screw with No Polarizing Hardware
6	Locknut with No Polarizing Hardware

Ordering Code Notes:

- 1) The 14 pin connector cover will not accept the length of wire wrap contacts.
- 2) Plastic covers with large clamps are only available for 36 Pin size connectors.
- 3) Metal covers with side entry may be converted to top entry by removing side plate and changing clamp orientation.
- 4) Covers may be ordered separately.
- 5) Insulator design prevents improper mating of individual plug and receptacle. Polarizing hardware enables specific plug and receptacle combinations.

519 SERIES



Rack And Panel Connectors

CONNECTOR MATING FACE VIEWS

DIMENSIONS INDICATED FOR EACH SIZE APPLY TO BOTH PLUG AND RECEPTACLE

14 PIN PLUG

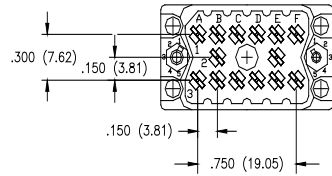

14 PIN RECEPTACLE

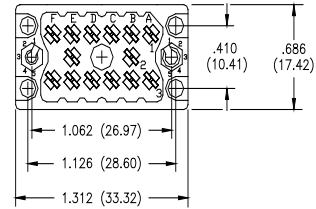

36 PIN PLUG

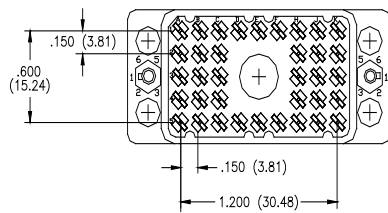

36 PIN RECEPTACLE

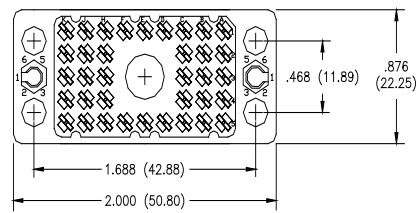

PLUG WITH ACTUATING SCREW AND POLARIZING GUIDE PINS

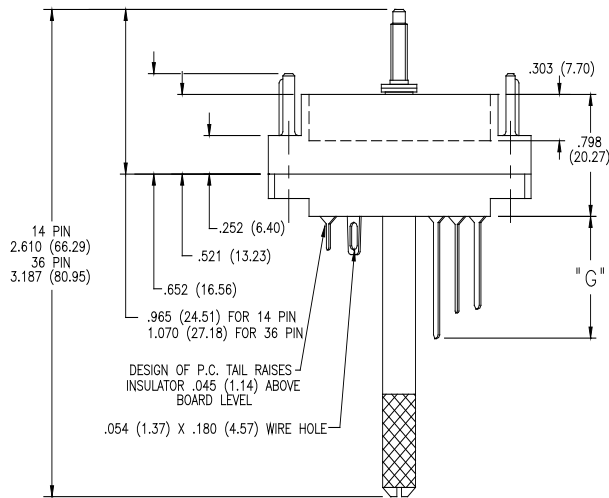

RECEPTACLE WITH LOCKNUT AND POLARIZING SOCKETS

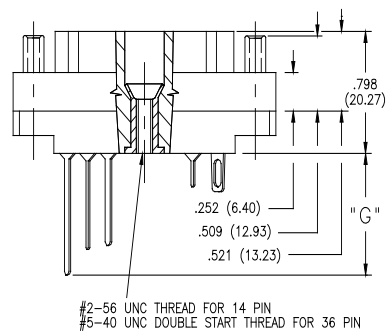

PLUG WITH ACTUATING SCREW, POLARIZING GUIDE PINS AND COVER

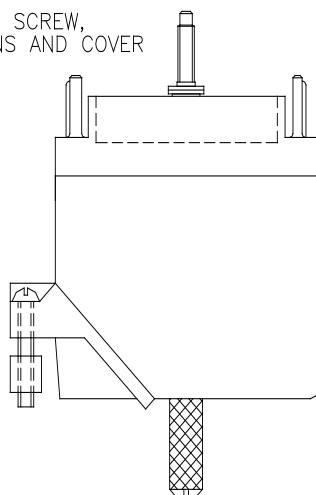

RECEPTACLE WITH LOCKNUT, POLARIZING SOCKETS AND COVER

